

# INSTRUKCJA MONTAŻU

FITTING-UP INSTRUCTION / AUFBAUANLEITUNG

MONTÁŽNÍ NÁVOD / MONTÁŽNY NÁVOD / SZERELÉSI UTASÍTÁS

Producent:  
**Restol sp. z o.o.**  
36-055 BRATKOWICE  
www.restol.com.pl

# Theo THB-1

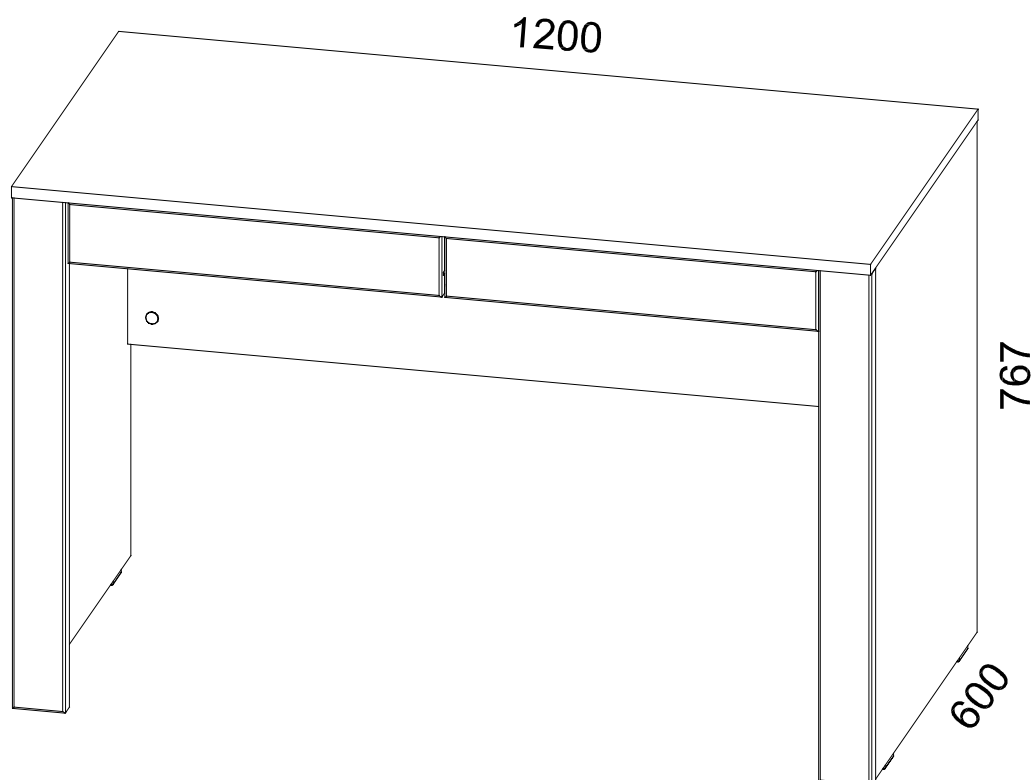
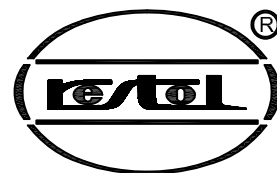

1200 x 767 x 600 /mm/

#### **WSKAZÓWKA na temat pielęgnacji mebla.**

Czyścić elementy wilgotną szmatką lub papierowym ręcznikiem.  
Nie używać chemicznych środków czyszczących.

#### **DIRECTION for the furniture cleaning.**

Clean elements with the moist wiper or soft paper towel. Do not use any detergents.

#### **Pflegehinweis.**

Nur mit feuchtem Lappen, bzw. Papiertuch Ihre Möbel reinigen.  
Keine chemischen Waschmittel einsetzen.

#### **POKYN pro ošetřování nábytku!**

Díly čistit vlhkým hadříkem nebo papírovou utěrkou.  
Nepoužívat chemické čističí prostředky.

#### **POKYNY k údržbě nábytku.**

Prvky nábytku čistit vlhkou handričkou alebo papierovou utierkou  
Nepoužívať chemické čistiace prostriedky.

#### **UTMATATÓ a bútor ápolására.**

Az elemeket nedves ronggyal vagy papírtörülközővel tisztítani.  
Vegyi tisztítószert nem használni.

Gwarancja dostępna pod linkiem:

Guarantee available at:

Die Garantie ist unter dem Link:

Záruka je k dispozici na

následujícím odkazu:

Záruka k dispozícii pod odkazom:

Link a jótálláshoz :

[www.restol.com.pl/gwarancja.pdf](http://www.restol.com.pl/gwarancja.pdf)

**INSTRUKCJA MONTAŻU**  
 FITTING-UP INSTRUCTION / AUFBAUANLEITUNG  
 MONTÁŽNÍ NÁVOD / MONTÁŽNY NÁVOD / SZERELÉSI UTASÍTÁS

# Theo THB-1



Do montázu potrzebne są:  
 You need for fitting-up:  
 Zur Montage werden Sie brauchen:  
 K montáži jsou potřebné:  
 Na montáž potrebujete:  
 A szereléshez szükséges:

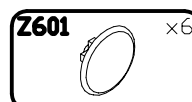
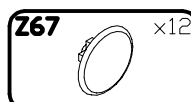
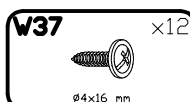
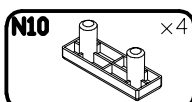
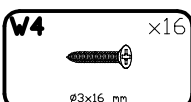
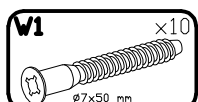
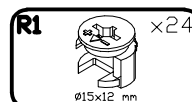
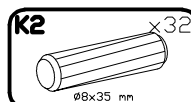
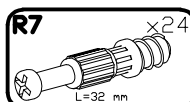
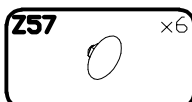
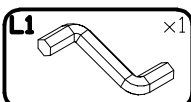
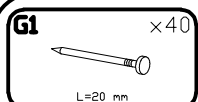
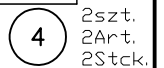
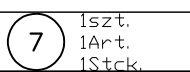
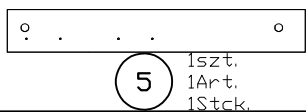
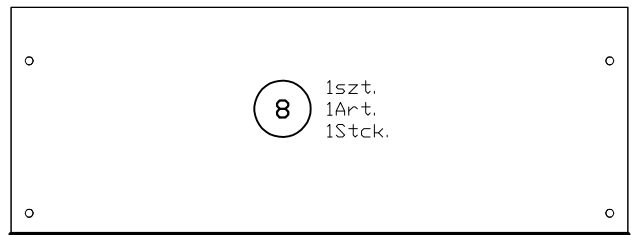
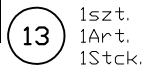
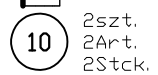
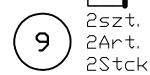
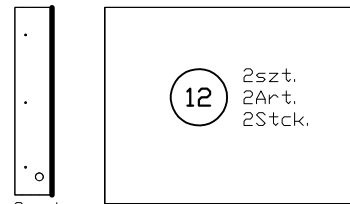
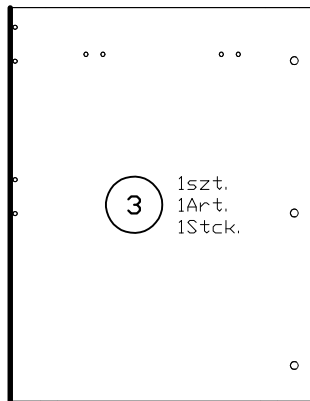
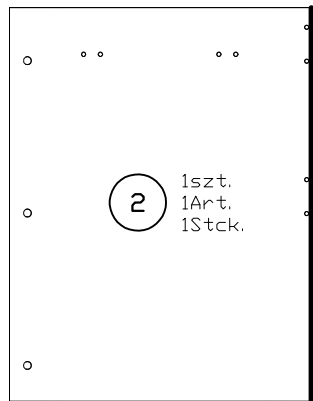
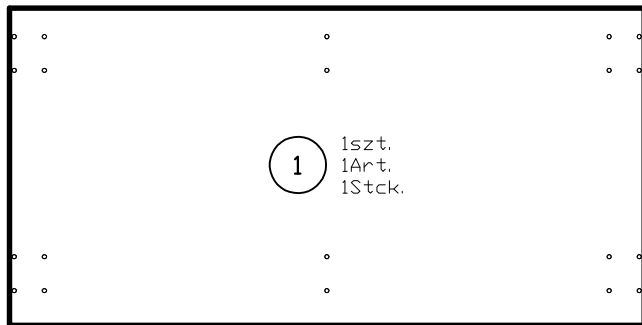
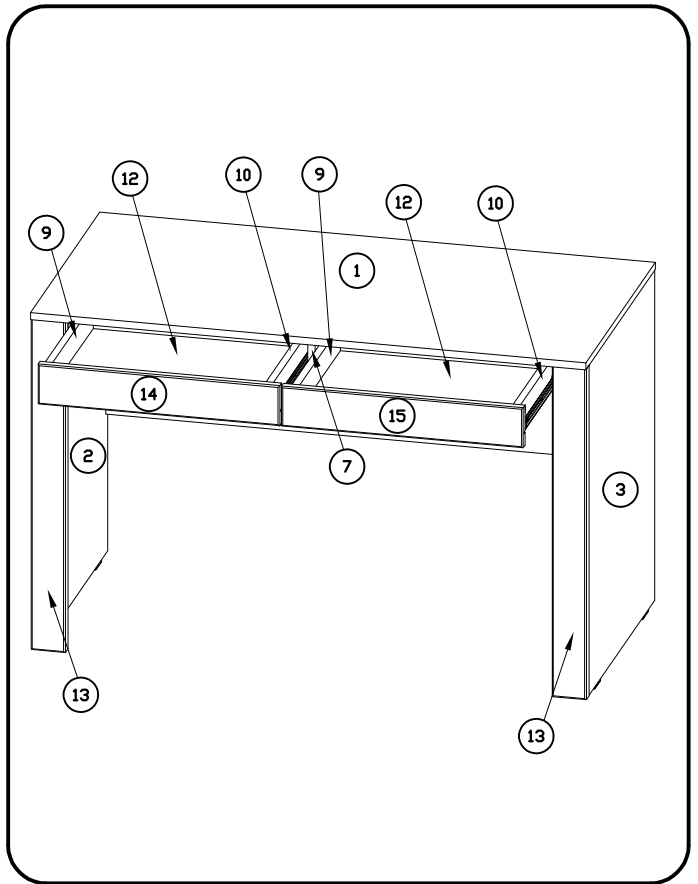
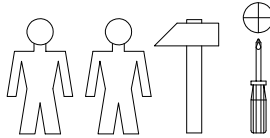

**PODCZAS MONTAŻU POSTĘPOWAĆ ZGODNIE Z INSTRUKCJĄ**

WHILE ASSEMBLING FOLLOW THE INSTRUCTION / MONTAGE LAUT DER AUFBAUANLEITUNG DURCHFÜHREN

PŘI MONTÁŽI POSTUPOVAT PODLE NÁVODU / PRI MONTÁŽI POSTUPOJTE PODĽA NÁVODU / SZERELÉSKOR UTASÍTÁS SZERINT ELJÁRNI

# 1<sup>THB</sup> THB-1

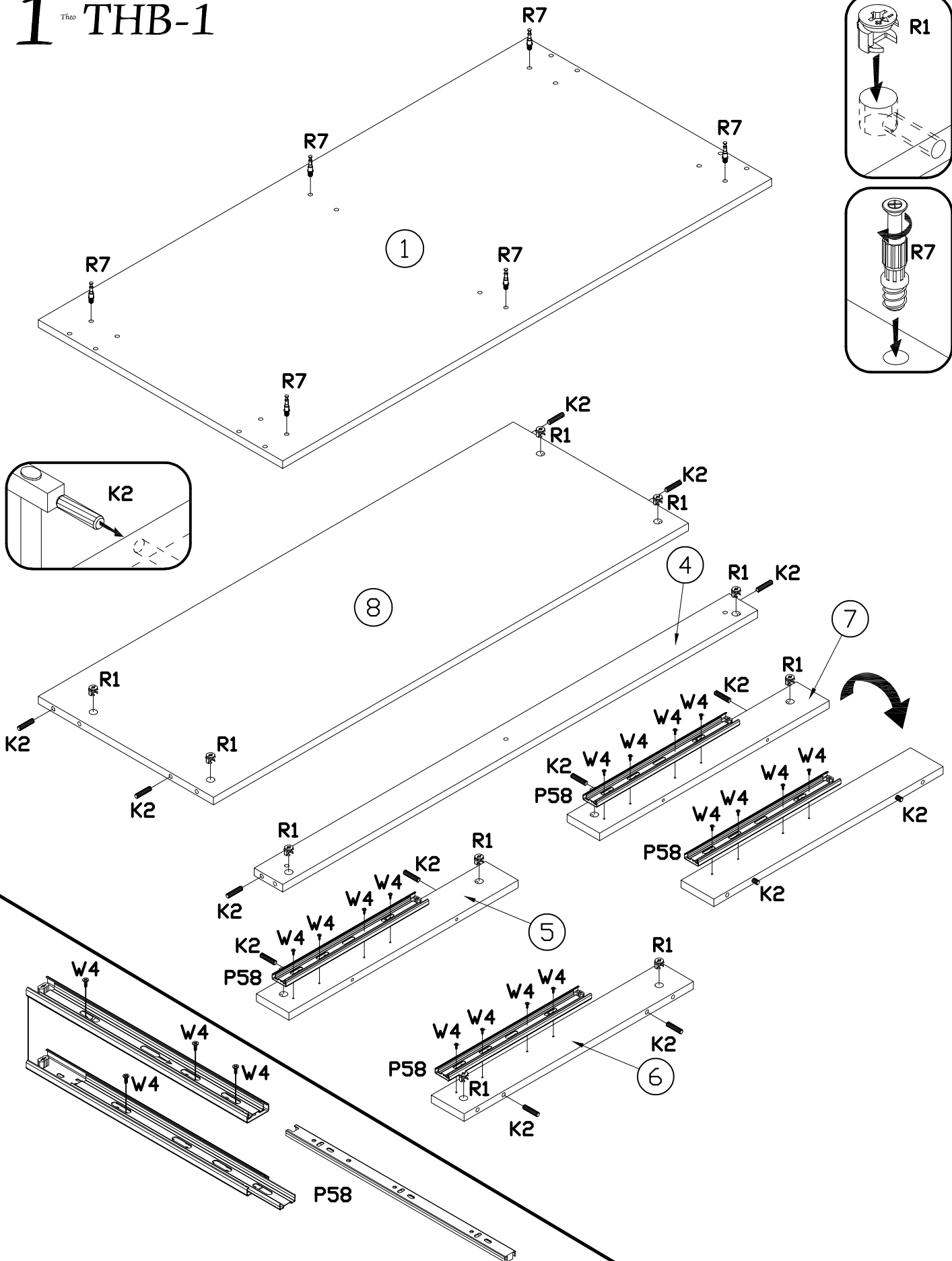

PODCZAS MONTAŻU POSTĘPOWAĆ ZGODNIE Z INSTRUKCJĄ

WHILE ASSEMBLING FOLLOW THE INSTRUCTION / MONTAGE LAUT DER AUFBAUANLEITUNG DURCHFÜHREN

PŘI MONTÁŽI POSTUPOVAT PODLE NÁVODU / PRI MONTÁŽI POSTUPOJTE PODĽA NÁVODU / SZERELÉSKOR UTASÍTÁS SZERINT ELJÁRNI

2 THB-1

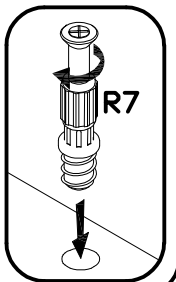
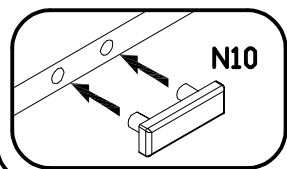
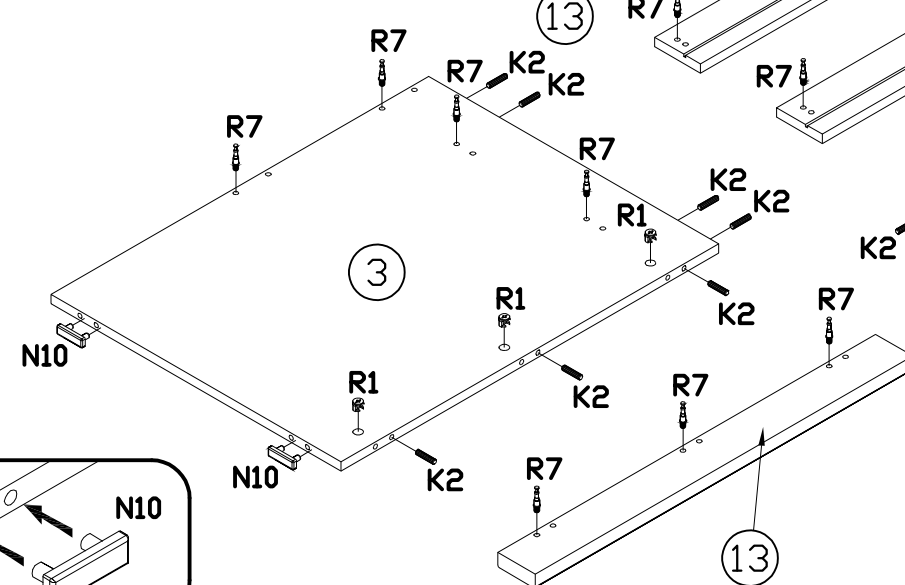
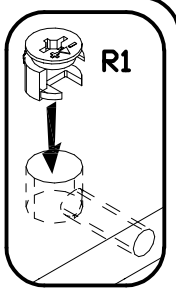
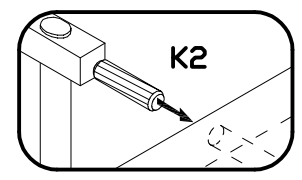
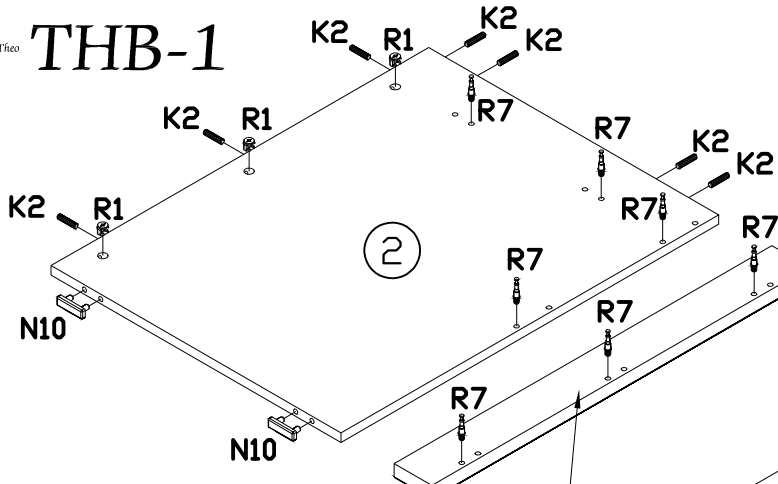

3 THB-1

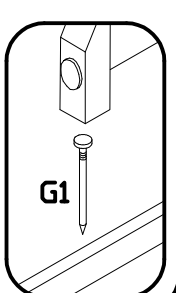
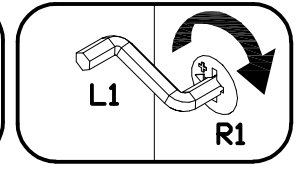
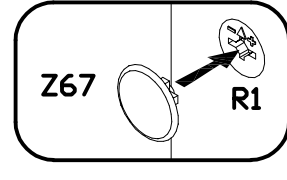
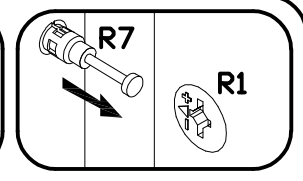
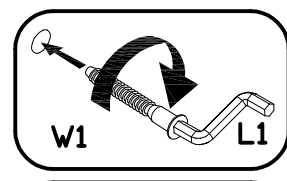
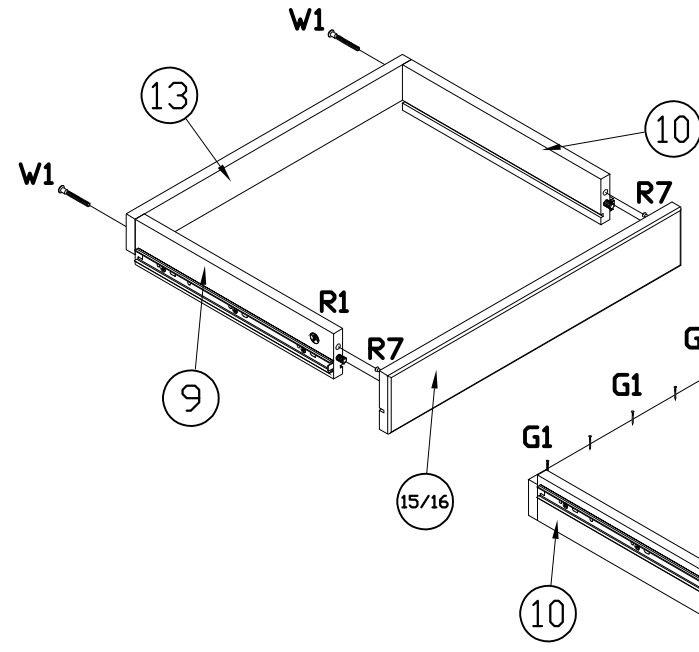

**PODCZAS MONTAŻU POSTĘPOWAĆ ZGODNIE Z INSTRUKCJĄ**

WHILE ASSEMBLING FOLLOW THE INSTRUCTION / MONTAGE LAUT DER AUFBAUANLEITUNG DURCHFÜHREN

PŘI MONTÁŽI POSTUPOVAT PODLE NÁVODU / PRI MONTÁŽI POSTUPOJTE PODĽA NÁVODU / SZERELÉSKOR UTASÍTÁS SZERINT ELJÁRNI

**4** Třico **THB-1**

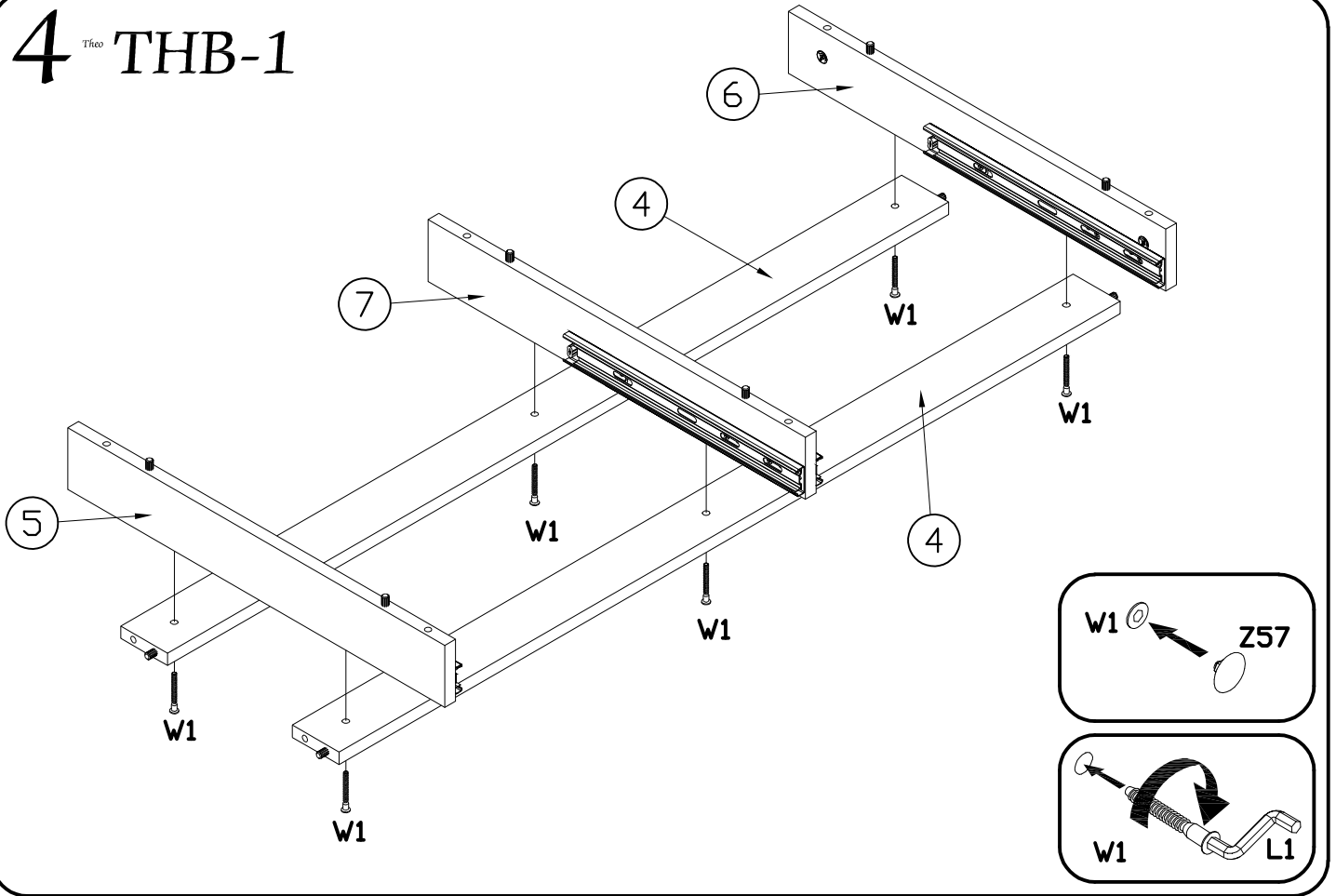

**5** Třico **THB-1**

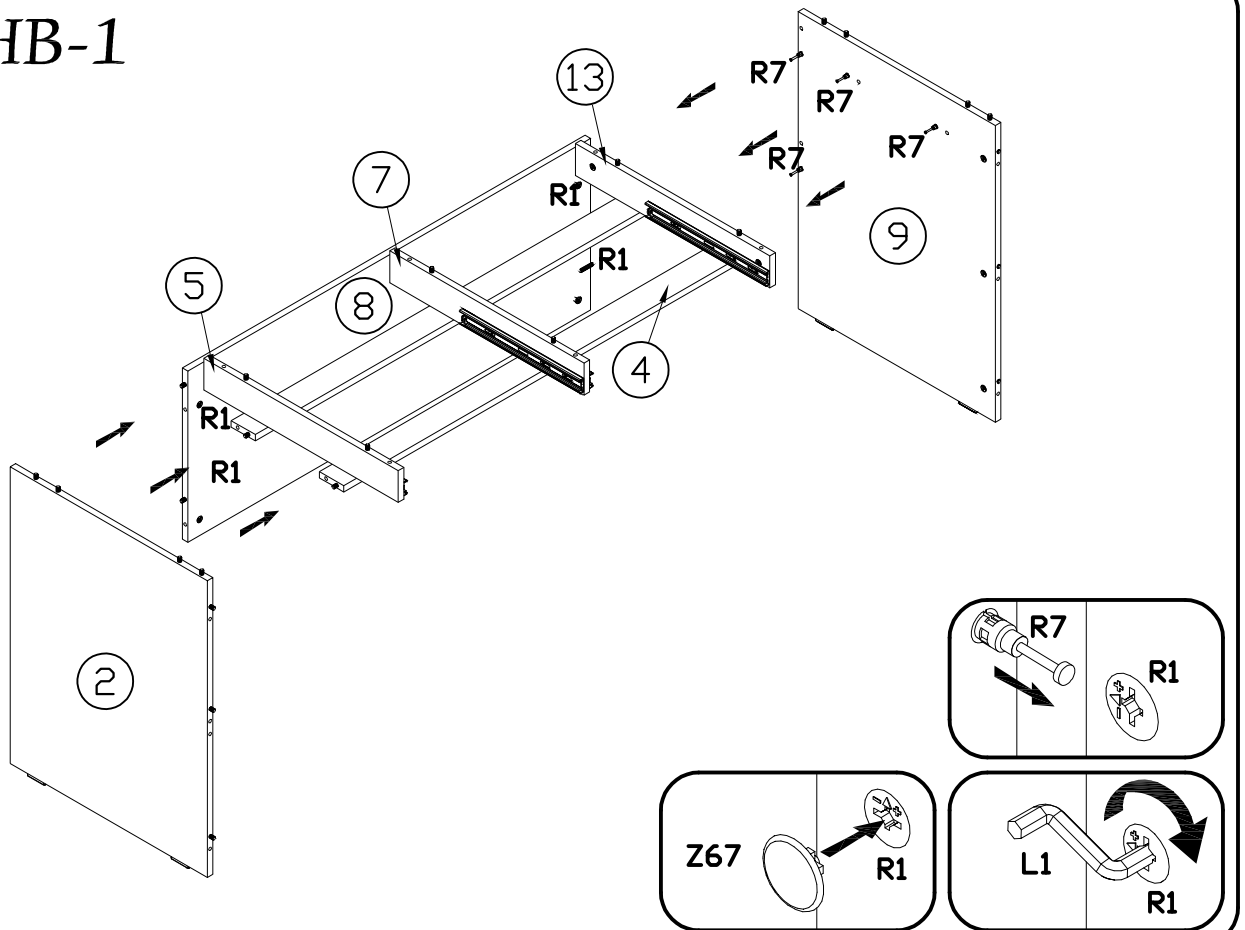

**PODCZAS MONTAŻU POSTĘPOWAĆ ZGODNIE Z INSTRUKCJĄ**

WHILE ASSEMBLING FOLLOW THE INSTRUCTION / MONTAGE LAUT DER AUFBAUANLEITUNG DURCHFÜHREN

PŘI MONTÁŽI POSTUPOVAT PODLE NÁVODU / PRI MONTÁŽI POSTUPOJTE PODĽA NÁVODU / SZERELÉSKOR UTASÍTÁS SZERINT ELJÁRNI

# 6<sup>Tfco</sup> THB-1

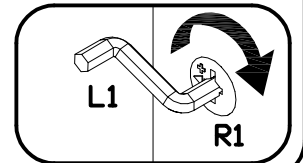
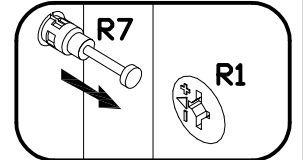
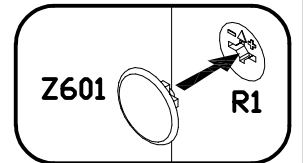
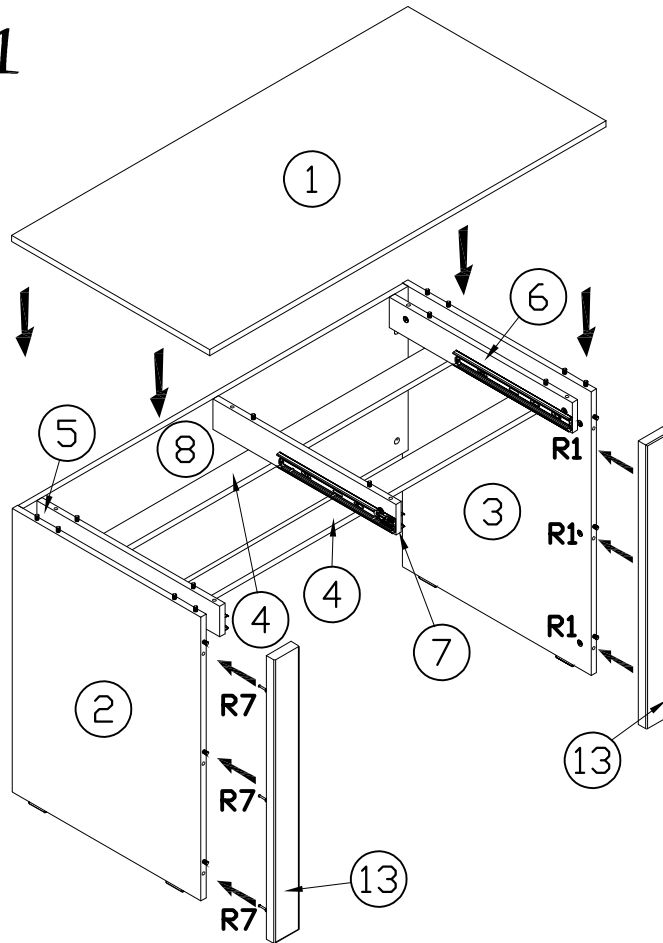

# 7<sup>Tfco</sup> THB-1

